

Bonfiglioli Riduttori

S series

Lista parti di ricambio

Spare parts list

Ersatzteilliste

Liste des pieces detachees

Lista de partes de recambio

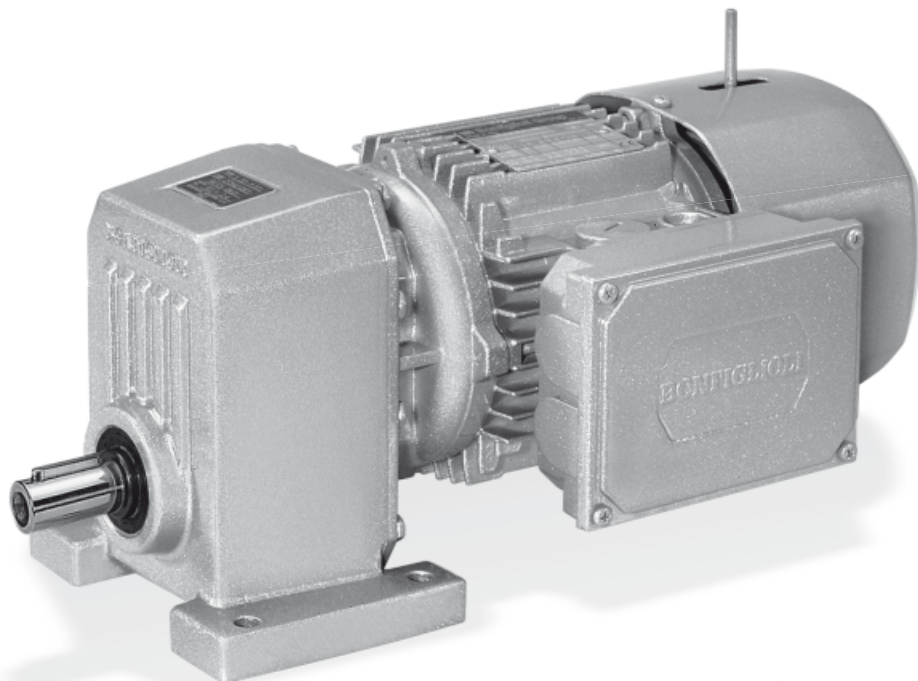

























**Quadro d'unione delle tavole
parti di ricambio**





Index of spare parts tables

Inhaltsverzeichnis Ersatzteillisten

*Index des tables de pièces
de rechange*

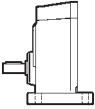
*Índice de la tabla de partes
de recambio*

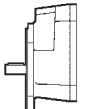
INPUT	S 10	S 20	S 30	S 40	S 50
 S_					
 P63 ... P132					
 P160 - P180					
 HS					

OUTPUT		S 10 ... S 50
	P	
	F	

S 10

S 20

S 30

S 40

S 50







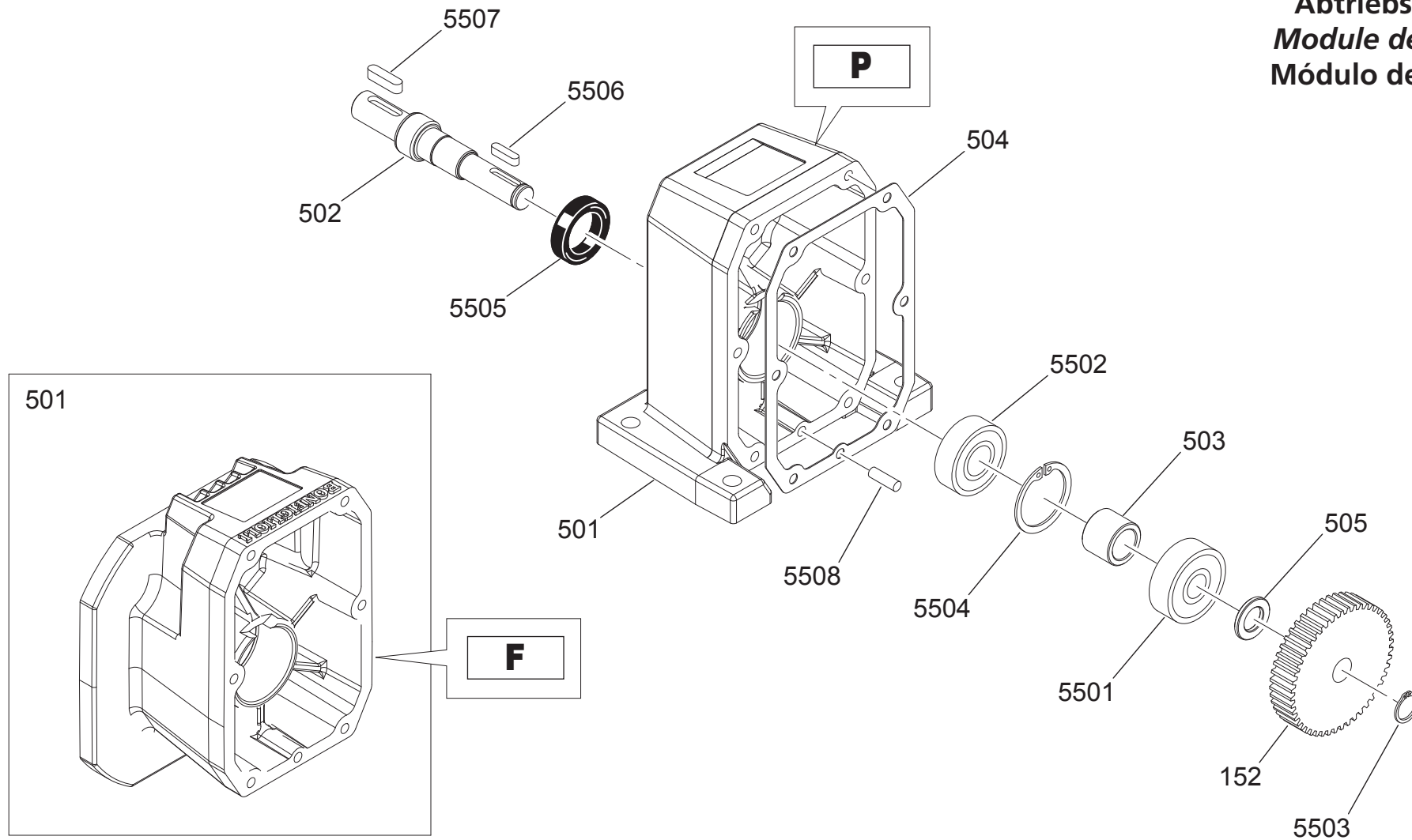

P

F

Modulo uscita
Output sub-assembly
Abtriebseinheit
Module de sortie
Módulo de salida



Pos.	Descrizione	Description	Benennung	Description	Descripción
152	Corona	Gear	Zahnrad	Couronne	Corona
501	Cassa	Housing	Gehäuse	Carter	Caja
502	Albero lento	Output shaft	Abtriebswelle	Arbre de sortie	Eje de salida
503	Distanziale	Spacer ring	Distanzring	Entretoise	Distanciador
504	Guarnizione	Gasket	Dichtung	Joint plat	Junta





									
	5501	5502	5504	5503	5508	5506	5507	505	5505
S 10	6301	6202	DI 35	DE 12	ø5x16	4x4x16 C	5x5x20 A	12.2x16.8x0.5	20x30x7 DL
S 20	6303	6303	DI 47	DE 15	ø5x16	5x5x17 C	6x6x35 A	26.9x15.5x3	25x42x7 DL
S 30	6304	6304	DI 52	DE 17	ø6x16	5x5x19 C	8x7x40 A	17.2x27.8x0.5	30x42x7 DL
S 40	6305	6305	DI 62	DE 20	ø6x16	6x6x25 C	8x7x50 A	20.5x34.8x1	35x52x7 DL
S 50	6307	6307 6307-2RS *	DI 80	DE 25	ø6x16	8x7x25 C	10x8x60 A	25.2x48.8x1	50x72x8 DL

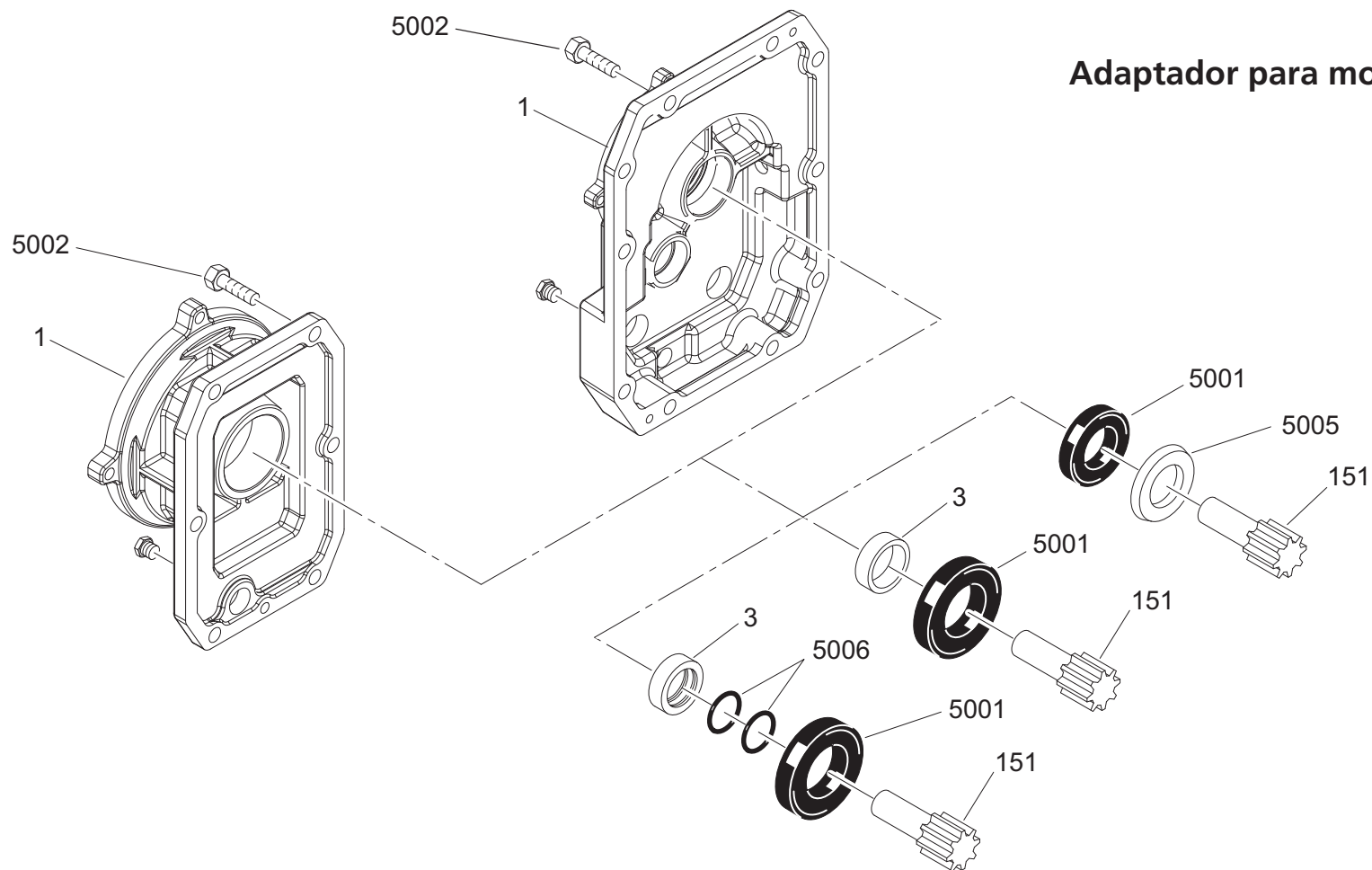

* Per posizioni di montaggio V3 e V6 / For mounting positions V3 and V6 / Für die Einbaulagen V3 und V6 / Pour positions de montage V3 et V6 / Para posiciones de montaje V3 y V6

Interfaccia per motore compatto
Compact motor interface
S Baueinheit
Module S
Adaptador para motor compacto



Pos.	Descrizione	Description	Benennung	Description	Descripción
1	Coperchio	Cover	Deckel	Couvercle	Tapa
3	Boccola	Bushing	Buchse	Douille	Casquillo
151	Pignone	Pinion gear	Ritzel	Pignon	Piñon



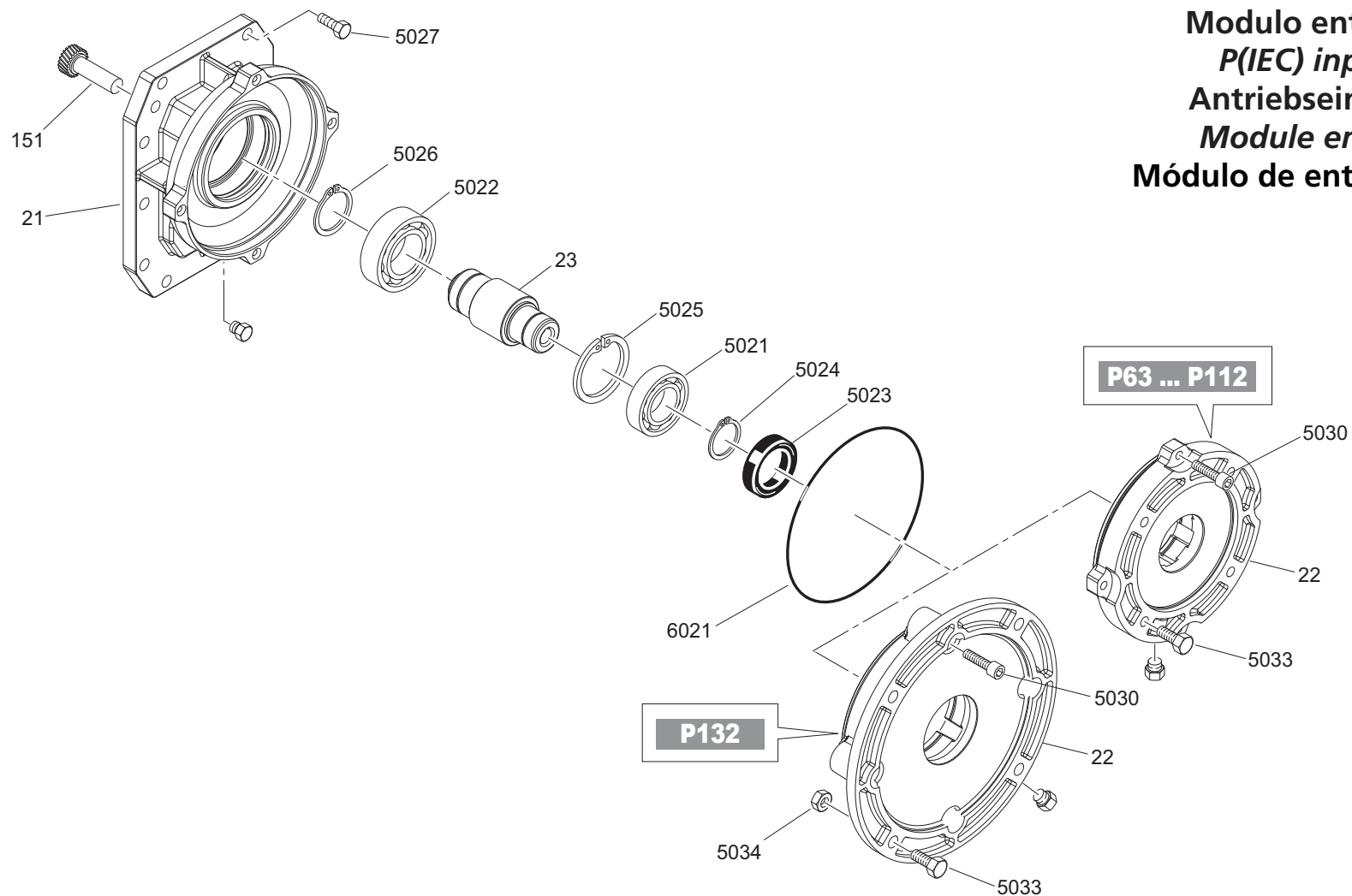

	 5001				 5005			 OR 5006	
	S 10	S 20	S 30	S 40 - S 50	S 10 - S 20	S 30	S 40 - S 50	S 20 - S 30	S 40 - S 50
S05	20x35x7 L 25x35x7 L	20x35x7 L 25x35x7 L			20x35x4				
S1	20x35x7 L 25x35x7 L	20x35x7 L 25x35x7 L	20x35x7 L 25x35x7 L	20x35x7 L 25x35x7 L	20x35x4	20x35x4	20x35x4		
S2	35x55x8 L	35x55x8 L 42x55x8 L	35x55x8 L 42x55x8 L	35x55x8 L 42x55x8 L	35x52x4.5	35x52x4.5	35x52x4.5	4137	4137
S3	35x62x7 L 48x62x8 L	35x62x7 L 48x62x8 L	35x62x7 L 48x62x8 L	35x62x7 L 48x62x8 L	35x52x4.5	35x52x4.5	35x52x4.5	4137	4137
S4				45x85x10 L 65x85x10 L			45x62x4.5		149



	 5002				
	S 10	S 20	S 30	S 40	S 50
S05	M6x22	M6x20			
S1	M6x22	M6x18 M6x22	M8x25	M8x25	M10x30
S2	M6x22	M6x22	M8x25	M8x25	M10x30
S3	M6x22	M6x22	M8x25	M8x25	M10x30
S4				M8x25	M10x30



Modulo entrata P(IEC)
P(IEC) input module
Antriebseinheit P(IEC)
Module entree P(IEC)
Módulo de entrada P(IEC)

Pos.	Descrizione	Description	Benennung	Description	Descripción
21	Coperchio	Cover	Deckel	Couvercle	Tapa
22	Flangia	Flange	Flansch	Bride	Brida
23	Albero veloce	Input shaft	Antriebswelle	Arbre rapide	Eje de entrada
151	Pignone	Pinion gear	Ritzel	Pignon	Piñon





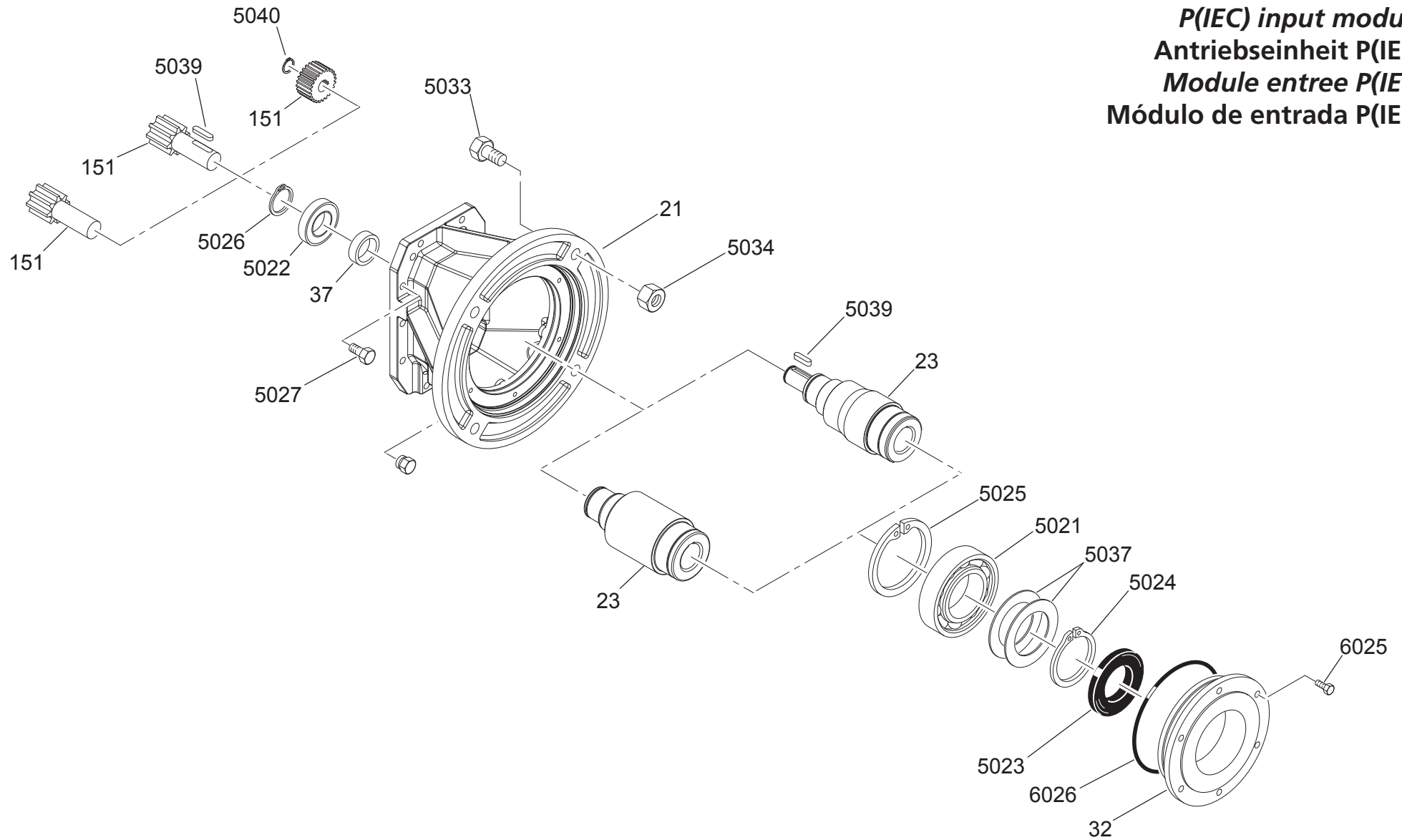



	 5027				5033		 5030		OR 6021 		 5034	 5023	
	S 10 - S 20	S 30	S 40	S 50	S 10 ... S 30	S 40 - S 50	S 10 ... S 30	S 40 - S 50	S 10 ... S 30	S 40 - S 50	S 40 - S 50	S 10 ... S 30	S 40 - S 50
	P63	M6x22	M8x25	M8x25	M10x30	M8x20	M8x20	M5x20	M5x20	3475	3475		25x42x7 L
P71	M6x22	M8x25	M8x25	M10x30	M8x20	M8x20	M5x20	M5x20	3475	3475		25x42x7 L	25x42x7 L
P80	M6x22	M8x25	M8x25	M10x30	M10x22	M10x22	M6x25	M6x25	3575	3575		40x62x7 L	40x62x7 L
P90	M6x22	M8x25	M8x25	M10x30	M10x22	M10x22	M6x25	M6x25	3575	3575		40x62x7 L	40x62x7 L
P100 P112	M6x22	M8x25	M8x25	M10x30	M12x30	M12x30	M6x30	M8x25	3575	3800		45x72x8 L	45x72x8 L
P132			M8x25	M10x30		M12x50		M8x25		3800	M12		55x80x8 L

	 5021				5022		 5024		5026		 5025	
	S 10 ... S 30	S 40 - S 50	S 10 ... S 30	S 40 - S 50	S 10 ... S 30	S 40 - S 50	S 10 ... S 30	S 40 - S 50	S 10 ... S 30	S 40 - S 50	S 10 ... S 30	S 40 - S 50
	P63	6005-2RS	6005-2RS	6006	6006	25	25	30	30	47	47	
P71	6005-2RS	6005-2RS	6006	6006	25	25	30	30	47	47		
P80	6008-2RS	6008-2RS	6007 6007 ETN9	6007 6007 ETN9	40	40	35	35	68	68		
P90	6008-2RS	6008-2RS	6007 6007 ETN9	6007 6007 ETN9	40	40	35	35	68	68		
P100 P112	6009-2RS	6009-2RS	6007 ETN9	6209	45	45	35	45	75	75		
P132		6012-2RS		6209		60		45		95		



Modulo entrata P(IEC)
P(IEC) input module
Antriebseinheit P(IEC)
Module entree P(IEC)
Módulo de entrada P(IEC)

Pos.	Descrizione	Description	Benennung	Description	Descripción
21	Coperchio	Cover	Deckel	Couvercle	Tapa
23	Albero veloce	Input shaft	Antriebswelle	Arbre rapide	Eje de entrada
32	Cappellotto per cuscinetto	Bearing holder	Deckel	Capuchon	Sombbrero para rodamiento
37	Distanziale	Spacer ring	Distanzring	Entretoise	Distanciador
151	Pignone	Pinion gear	Ritzel	Pignon	Piñon







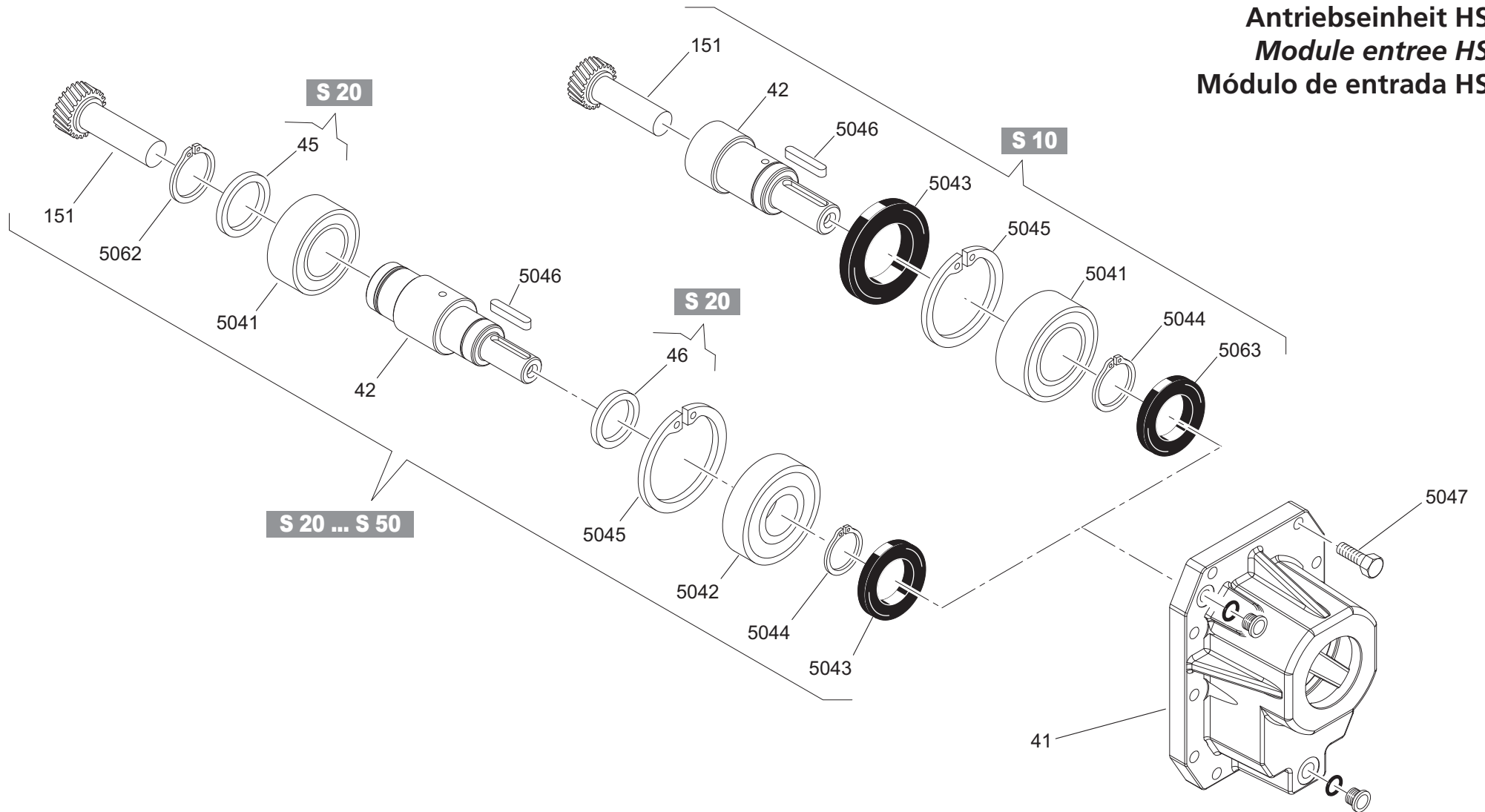

														
	5021	5022	5039	5024	5026	5040	5025	5037	5034	5023	5027	5033	6025	6026
P160	6016 6016 2RS	NUP310 6310	8x7x45 A	80	50	30	140	80x100x2 P	M16	80x110x10 L	M10x30 M10x35 M10x45	M16x60	M8x25	3725
P180	6016 6016 2RS	NUP310 6310 6212	8x7x45 A 14x9x57 C	80	50 60	30 48	140	80x100x2 P	M16	80x110x10 L	M10x30 M10x35 M10x45	M16x60	M8x25	3725

S 10**S 20****S 30****S 40****S 50****HS**

Modulo entrata HS
HS input module
Antriebseinheit HS
Module entree HS
Módulo de entrada HS



Pos.	Descrizione	Description	Benennung	Description	Descripción
41	Coperchio	Cover	Deckel	Couvercle	Tapa
42	Albero veloce	Input shaft	Antriebswelle	Arbre rapide	Eje de entrada
45	Distanziale	Spacer ring	Distanzring	Entretoise	Distanciador
46	Distanziale	Spacer ring	Distanzring	Entretoise	Distanciador
151	Pignone	Pinion gear	Ritzel	Pignon	Piñon

									
	5041	5042	5043	5063	5046	5044	5062	5045	5047
S 10	3206-2RS		35x62x7 L	30x40x4 L	5x5x35 A	30		62	M6x22
S 20	6007	6206-2RS	30x52x7 L		6x6x35 A	30	35	62	M6x22
S 30	6207	6306-2RS	30x52x7 L		6x6x35 A	30	35	72	M8x30
S 40	6210	6308-2RS	40x62x7 DL		8x7x45 A	40	50	90	M8x30
S 50	6210	6308-2RS	40x62x7 DL		8x7x45 A	40	50	90	M10x35

R1

	Descrizione	Description	Benennung	Description	Descripción

110719

Questa pubblicazione annulla e sostituisce ogni precedente edizione o revisione. Ci riserviamo il diritto di apportare modifiche senza preavviso. E' vietata la riproduzione anche parziale senza autorizzazione.

This publication cancels and replaces any previous edition and revision. We reserve the right to implement modifications without notice. This catalogue cannot be reproduced, even partially, without prior consent.

Diese Veröffentlichung annulliert und ersetzt jeder hergehende Edition oder Revision. BONFIGLIOLI behält sich das Recht vor, Änderungen ohne vorherige Informationen durchzuführen.

Cette publication annule et remplace toutes les autres précédentes. Nous nous réservons le droit d'apporter toutes modifications à nos produits. La reproduction et la publication partielle ou totale de ce catalogue est interdite sans a autorisation.

Esta publicacion anula y sustituye toda anterior edicion o revision. Nos reservamos el derecho de aportar modificaciones sin previo aviso. Se prohíbe la reproduccion incluso parcial sin autorizacion.



Dal 1956 Bonfiglioli progetta e realizza soluzioni innovative ed affidabili per il controllo e la trasmissione di potenza nell'industria e nelle macchine operatrici semoventi e per le energie rinnovabili.

Bonfiglioli has been designing and developing innovative and reliable power transmission and control solutions for industry, mobile machinery and renewable energy applications since 1956.

Seit 1956 plant und realisiert Bonfiglioli innovative und zuverlässige Lösungen für die Leistungsüberwachung und -übertragung in industrieller Umgebung und für selbstfahrende Maschinen sowie Anlagen im Rahmen der erneuerbaren Energien.

Depuis 1956, Bonfiglioli conçoit et réalise des solutions innovantes et fiables pour le contrôle et la transmission de puissance dans l'industrie et dans les machines automotrices et pour les énergies renouvelables.

Bonfiglioli diseña y crea soluciones de control y transmisión de potencia innovadoras y fiables para la industria, las máquinas autopropulsadas y la producción de energías renovables desde 1956.

HEADQUARTERS

Bonfiglioli Riduttori S.p.A.
Via Giovanni XXIII, 7/A
40012 Lippo di Calderara di Reno
Bologna (Italy)

tel: +39 051 647 3111
fax: +39 051 647 3126
bonfiglioli@bonfiglioli.com
www.bonfiglioli.com

BR_SPR_S_STD_I-UK-F-DE-E_R00_0

